

Cordless Endodontic Treatment Motorized Handpiece

Provider
endo★star

INSTRUCTIONS FOR USE



Thank you for purchasing the Endostar Provider.

For optimum safety and performance, read this manual thoroughly before using the unit and pay close attention to warnings and notes. Keep this manual in a readily accessible place for quick and easy reference.

Poldent Co. Ltd.

Table of Contents

Accident Prevention.....	3
Precautions.....	5
Features.....	6
Parts Identification and Accompanying Items.....	7
Usage.....	8
(1) Operating Environments.....	8
(2) Before Using the Ensostar Provider.....	8
Charging the Battery.....	8
Connecting the Contra Angle.....	9
File Installation.....	10
Calibration.....	10
Operation Check.....	11
(3) Operation.....	12
Basic Operation.....	12
Memory Settings: Initial Settings.....	13
Memory Settings: Primary Functions.....	13
Memory Settings: Additional Operation Settings (OTR Mode).....	14
Memory Settings: Additional Operation Settings (Normal Mode).....	15
Memory Settings: Other Settings.....	16
Restoring the Initial Settings.....	17
(4) After Using the Endostar Provider.....	17
Removing the File.....	17
Operation with Endostar Navigator.....	18
Installing the File Electrode.....	18
Connecting the Transmission Cable.....	19
Operation Check.....	19
Meter Display.....	20
Operation.....	20
Cleaning the Rotor Axle and the Built-in Electrode.....	22
Cleaning the Rotor Axle and the Built-in Electrode.....	23
Replacing the Built-in Electrode with the External File Electrode.....	24
Maintenance.....	26
Autoclavable Components.....	26
Other Components: Wiping with Ethanol (70 vol% to 80 vol%).....	30
Other Components: Washing and Wiping with Ethanol (70 vol% to 80 vol%).....	31

Replacement Parts, Transport and Storage Environments	32
(1) Replacement Parts	32
Replacing the Battery.....	32
Replacing the Built-in Electrode.....	33
(2) Transport and Storage Environments	34
Inspection and Warranty	35
Regular Inspection.....	35
Inspection Items.....	35
Warranty.....	36
Troubleshooting	37
Technical Specifications	39
Specifications.....	39
Symbols.....	40
Electromagnetic Disturbances (EMD)	41
Electromagnetic Disturbances (EMD).....	41
Essential Performance.....	44
Cable List.....	44

Trademarks (™) and Registered Trademarks (®):

The names of companies, products, services, etc. used in this manual are either trademarks or registered trademarks owned by each company.

Accident Prevention

Customers

Make sure to obtain clear instructions concerning the various ways to use the device described in this accompanying manual.

Preventing Accidents

Most operation and maintenance problems result from insufficient attention to basic safety precautions and not being able to foresee potential accidents.

Problems and accidents are best avoided by anticipating potential dangers and operating the device in accordance with the manufacturer's recommendations. First, thoroughly read all precautions and instructions pertaining to safety and accident prevention. Then operate the device with the utmost caution to prevent either damaging the device itself or causing bodily injury.

The following symbols and expressions indicate the degree of danger and harm that could result from ignoring the corresponding instructions:

WARNING

This alerts the user of the possibility of extremely serious injury or complete destruction of the device, as well as other property damage including the possibility of fire.

CAUTION

This alerts the user of the possibility of minor or moderate injury or damage to the device.

The warning symbols () and caution symbols () that appear next to the main text on the right hand side of the page refer to and are explained by the Warnings and Cautions at the bottom of the page.

 This alerts the user of important points concerning operation or the risk of equipment damage.

The user (e.g., healthcare facility, clinic, hospital etc.) is responsible for the management, maintenance, and use of medical devices.

This equipment must only be used by dentists and other legally licensed professionals.
Do not use the Endostar Provider for anything other than its specified dental purpose.

Disclaimers

- Poldent Co. Ltd. will not be responsible for accidents, equipment damage, or bodily injury resulting from:
 1. Repairs made by personnel not authorized by Poldent Co. Ltd.
 2. Any changes, modifications, or alterations of its products
 3. The use of products made by other manufacturers, except for those procured by Poldent Co. Ltd.
 4. Maintenance or repairs using parts or components other than those specified by Poldent Co. Ltd. or other than in their original condition
 5. Operating the device in a manner other than described in the operating procedures in this manual or in a manner inconsistent with the safety precautions and warnings in this manual.
 6. Workplace, environmental, or installation conditions that do not conform to those stated in this manual, such as an improper electrical power supply.
 7. Fires, earthquakes, floods, lightning, natural disasters, or forces majeure.
- The useful life of the Endostar Provider is 6 years from the date of installation provided it is regularly and properly inspected and maintained.

In Case of Accident

If an accident occurs, the Endostar Provider must not be used until repairs have been completed by a qualified and trained technician authorized by the manufacturer.

User Qualifications

Intended Operator Profile

- a) Qualification : Legally qualified person such as dentists for endodontic device operation (it may differ among countries).
- b) Education and Knowledge : It is assumed that the user understands the risks of root canal measuring and treatment. It is also assumed the user is thoroughly familiar with root canal measuring and treatment including the prevention of cross contamination.
- c) Language Understanding : English (Intended for professional use as described above)
- d) Experience : Experienced person with operating endodontic device.
No special training is required except in cases where this is required by legal regulations of the relevant country or region.

Patient Population

Age	Child to Elderly
Weight	N/A
Nationality	N/A
Sex	N/A
Health	It is not intended for use on patients wearing pacemakers or ICDs.
Condition	Conscious and mentally alert person. (Person who can stay still during treatment.)



CAUTION

- When the device is connected to the Endostar Navigator, an apex locator, it is not recommended that this device be used with children under 12 years of age.

Precautions

* Poldent Co. Ltd. is not responsible for any accidents or other types of trouble that are caused by not following the precautions noted below.

WARNING

- Except for ways described in this manual, the device must not be connected to or used in combination with any other apparatus or system. It must not be used as an integral component of any other apparatus or system. Poldent Co. Ltd. will not be responsible for accidents, device damage, bodily injury or any other trouble which results from ignoring this prohibition.
- A rubber dam should be used when performing endodontic treatment.
- No modification of the device is allowed.
- Instruments which produce considerable electrical noise such as electric scalpels can cause the Endostar Provider to operate abnormally. Turn the Endostar Provider off before using any instruments that produce electrical noise.
- Do not use the device on patients who have a pacemaker or an Implantable Cardioverter Defibrillator (ICD). It could cause the pacemaker or the Implantable Cardioverter Defibrillator (ICD) to function abnormally.
- Illumination devices such as fluorescent lights and film viewers which use an inverter can cause the Endostar Provider to operate erratically. Do not use the Endostar Provider near lights such as these.
- The device must not be connected to or used in combination with any other apparatus or system. It must not be used as an integral component of any other apparatus or system.
- Do not use the device in the medical operation room.
- Blocked canals cannot be accurately measured.
- Do not perform maintenance while using the device for treatment.

Features

■ Indications for Use

The Endostar Provider is a compact, cordless endodontic treatment motorized handpiece for preparation and enlargement of root canals. It may be connected to the Endostar Navigator (Poldent Co. Ltd.), an apex locator (sold separately). It can be used to enlarge and prepare root canals, remove of gutta-percha point and softened dentin, and professional mechanical tooth cleaning.

Instructions for how to use the device when it is connected to the Endostar Navigator are printed on a blue background.

■ Liquid Crystal Display (LCD)

The LCD is easy to read and shows all settings as well as how the motor is running.

■ Controls

< OTR (Optimum Torque Reverse) Mode >

If the file torque is less than the set value, the file will keep rotating in the forward direction. When the file torque is more than the set value, the file will automatically start rotating 90° in reverse and 180° forward repeatedly. Furthermore, OTR mode can set various motor controls as described below.

Speed	: 100, 300, and 500 rpm
Torque Setting	: 0.2, 0.4, 0.6, 0.8, and 1.0 Ncm
Auto Start & Stop*	: The file starts when it is inserted in the canal and stops when it is taken out.
Apical Reverse or Stop*	: The motor reverses or stops when the tip of the file reaches a preset position inside the canal.

* These functions are available only when the device is connected to the Endostar Navigator.

< Normal Mode >

If the file torque is less than the set value, the file will keep rotating in the forward direction. When the file torque is more than the set value, the file will automatically start rotating in reverse direction. Furthermore, normal mode can set various motor controls as described below.

Speed	: 50, 100, 150, 200, 250, 300, 400, 500, 600, 800, and 1000 rpm
Torque Reverse	: The motor automatically reverses its rotation if the torque load exceeds the set value to reduce the risk of jamming.
Slow Down	: The file slows down as torque increases. The file slows down as it approaches the apex if the device is connected to the Endostar Navigator.
Forward & Reverse	: The file may rotate in both forward and reverse directions.
Auto Start & Stop*	: The file starts when it is inserted in the canal and stops when it is taken out.
Apical Reverse or Stop*	: The motor reverses or stops when the tip of the file reaches a preset position inside the canal.
Apical Torque Reduction*	: The automatic torque reverse value is reduced as the file tip approaches the apex.

* These functions are available only when the device is connected to the Endostar Navigator.

■ Memory

Six combinations of speed, torque, etc. can be memorized.





Parts Identification and Accompanying Items

Parts Identification

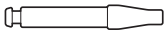

Accompanying Items (Parts of Device and Consumables)

Standard Parts

Power Supply Cord (Qty: 1)	Guide Bar (Qty: 1)	LS OIL (Qty: 1)
	<p>* Use the guide bar when replacing the built-in electrode or external file electrode.</p> <p> pp. 22 and 23 "Cleaning the Rotor Axle and the Built-in Electrode"</p> <p> p. 33 "Replacing the Built-in Electrode"</p> 	

Optional Parts

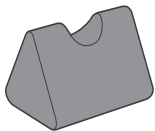
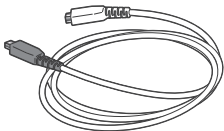
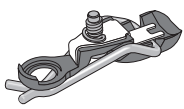
Handpiece Rest (Qty: 1)	Transmission Cable (Qty: 1)	External File Electrode (Qty: 1)
		

Usage

(1) Operating Environments

Temperature: +10°C to +40°C (+50°F to +95°F)

Humidity: 30% to 80% (without condensation)

Atmospheric Pressure: 70 kPa to 106 kPa

* If the device has not been used for some time, make sure it works properly before using it again.

(2) Before Using the Ensostar Provider

Before using the device, be sure that all autoclavable components have been sterilized.

☞ p. 26 "Autoclavable Components"

Charging the Battery

The battery is built into the motor handpiece.

* Ambient (room) temperature for charging is from +10°C to +35°C (+50°F to +95°F).

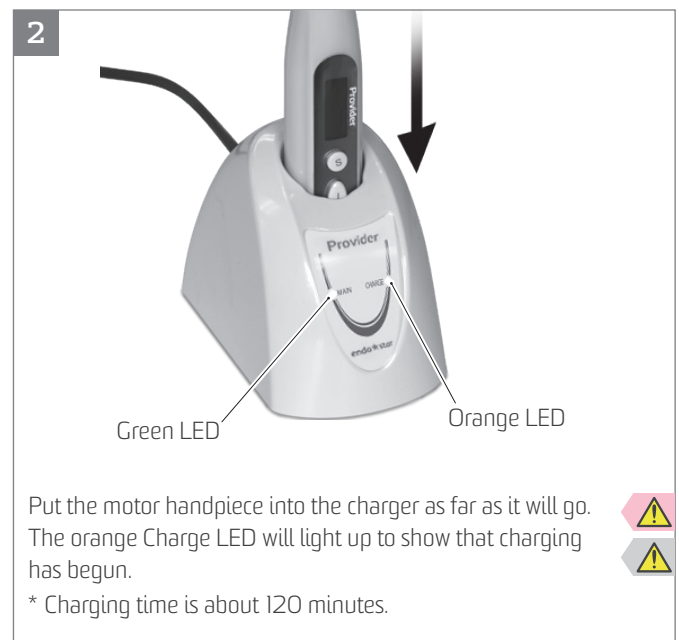

- ❗ Charge the battery as soon as the battery power indicator gets down to its last bar.
- ❗ If the orange charge LED goes off immediately or doesn't light up when the motor handpiece is put into the charger, the battery is probably fully charged. To make sure, take the motor handpiece out and put it back in again.
- ❗ Make sure the contact areas for the motor handpiece and charger are free of debris, especially metal fragments. Wipe with ethanol (70 vol% to 80 vol%) to remove any foreign debris. Do not press down too hard to wipe the charging areas; this could bend the electrical contacts.
- ❗ Do not leave the charger where it will be exposed to direct sunlight.
- ❗ Unplug the battery charger when it is not being used.

⚠ WARNING

- If an electrical storm occurs while the battery is being charged, do not touch the charger or its cord as there would be a risk receiving an electric shock.
- Do not get the charger wet or use it where it might get wet.

⚠ CAUTION

- The battery is not charged when the device is shipped and must be charged before using the device.
- Do not pull or yank the cord when disconnecting the power supply cord. Always grip the connectors.
- Use only the power cord provided and plug both ends all the way in.
- Charger and power supply cord must be located outside the so called patient environment (1.5 m around the patient location).

Charging the Battery



The number of bars shows how much battery power is left. Recharge the battery when there is only one bar left.



If the battery runs almost completely out, the device will automatically turn itself off after about 10 seconds. Recharge the battery as soon as possible.



If the battery power is very low and a large load is applied to the file, the motor may stop or the device may turn itself off. This is for safety; there may not be enough power to run the motor with sufficient stability. Recharge the battery if the display shown to the left appears frequently.

Connecting the Contra Angle

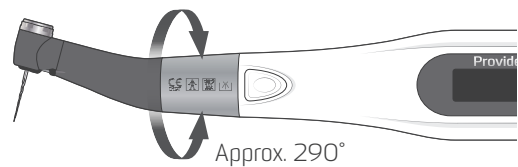
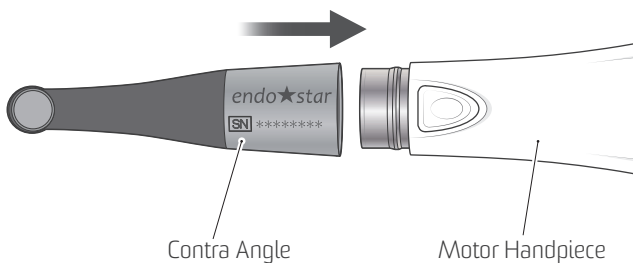

The rotation range of the contra angle is about 290°. Set it so that it reaches the treatment area and the display is easy to see.

! Do not force the contra angle to rotate beyond its limit.

Push the contra angle onto the motor handpiece until there is an audible click.

* The contra angle must be lubricated with the LS OIL before using for the first time. p. 28 "Lubrication"



! WARNING

- Make sure the connection components for both the motor handpiece and the contra angle are not damaged. An improper connection could cause the motor to reverse unexpectedly and result in injuring the patient.

! CAUTION

- Push the contra angle all the way onto the motor handpiece and then give it a light tug to make sure it is securely attached.

File Installation

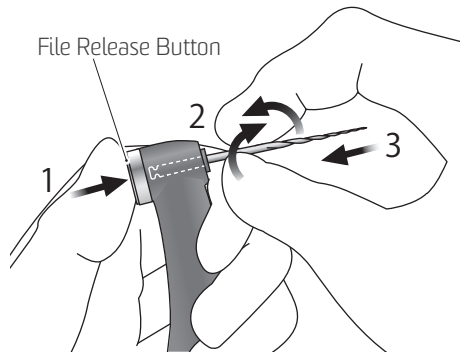

1. Hold down the file release button
2. Insert the file and turn it back and forth until it lines up with the latch mechanism.
3. Push the file all the way into the latch. Release the file release button.



- ! It's easiest to hold the button down if you put your index finger where the head joints the body.
- ! Use either Nickel-titanium or stainless steel files.

Calibration

* Before using right after purchase, whenever the motor handpiece or contra angle has been replaced, or if the motor alternates between forward and reverse rotation outside the canal, calibrate the device in the following way:



1. Turn the device on.
2. Make sure the battery is fully charged (three bars are displayed).
3. Put a commonly used file into the contra angle.
4. Press the Plus or Minus Switch and then select memory M6.
5. Hold down the Select Switch for 2 seconds or more.
6. Set the rotation mode to "Rev".
7. Turn the device off. (Hold the Select Switch and the press the Main Switch.)
8. Hold the Plus and Minus Switches and the press the Main Switch to turn the device back on.
9. When "CO-Adjst" appears in the display, press the Select Switch. The motor will start running. Make sure there is no load on the file.
10. When "Finished" appears in the display, the motor will stop and the calibration will be completed. Press the Main Switch to go to the standby display.

* Once calibration has been completed, you may change the M6 setting and you may turn the device off with a setting other than M6.

* If the device uses a file electrode, calibrate the device by putting the electrode on the file and connecting the device to a Endostar Navigator which is turned on.

WARNING

- Never use deformed or damaged files.
- Make sure the file goes all the way in. Give the file a light tug to confirm it is securely held in place. If the file is not securely placed, it could come out and injure the patient.
- Do not use reciprocal files (ones made to rotate back and forth). These could perforate the apical foramen when they reverse rotation.

CAUTION

- Use caution when inserting and removing files to avoid injury to fingers.
- Inserting and removing files without holding the file release button down will damage the chuck.
- Make sure the device is turned off before inserting or removing files.
- Do not connect the file electrode if the motor handpiece is not connected to the Endostar Navigator.

Operation Check

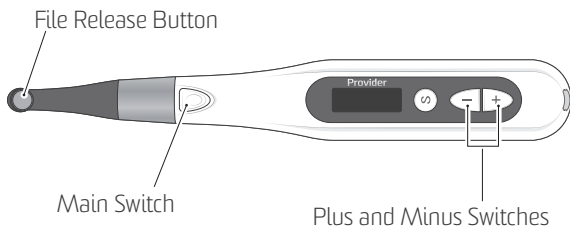

Error: 00
Chk - 0M

If a malfunction occurs, the device will stop working.
 ☞ p. 37 "Troubleshooting"

If this error display appears frequently, stop using the device and contact Poldent Co. Ltd. The number that appears after Error will depend on the type of malfunction.

- Make sure the contra angle and motor handpiece are properly and securely connected.
- Make sure the file is securely installed; give it a light tug.
- Check switch operation.

Turn the Main Switch on and use the Plus or Minus Switch to select a memory. Then press the Main Switch again to see if the device runs smoothly.



How to check device operation when it is connected to the Endostar Navigator;
 ☞ pp. 18 to 25 "Operation with Endostar Navigator".

⚠ WARNING

- Operate the device outside the oral cavity to make sure it will operate properly before using it for treatment.
- Some canals may be impossible to enlarge; always take an X-ray to check.
- Nickel-titanium file may suddenly snap depending on the curvature and shape of the canal; stop using the file if you notice or feel anything amiss.
- Files will eventually break due to metal fatigue and should be replaced before they reach this point.
- Electric noise or a malfunction could interfere with the motor control. Do not depend entirely on the device controlling itself; always watch the display and be aware of tactile feedback.
- Files will jam and break if too much force is applied to them.
- Files may break even when the torque reverse is turned on, depending on the setting value. Never exert excessive force on the file.
- Files designed for use with engines break easily if too much force is applied. Also do not use these files for canals with excessive curvature.
- Always examine files for stretching and other deformities or damage before using them. Any type of deformity could result in the file breaking.
- Do not let the file release button on the contra angle press against the teeth opposite to the treatment area; this could cause the file to come out and result in an injury.
- Do not press the file release button while the motor is running. It could heat up and cause a burn, or the file could come out and cause an injury.

⚠ CAUTION

- Stop using the device if you feel or notice anything unusual. The device cannot be used for every canal and should be used along with manual enlargement.
- File break more easily at fast speeds; always follow the file manufacturer's usage recommendations. Also always check the speed settings before use.
- Do not use any type of files except nickel-titanium and stainless steel ones.
- Nickel-Titanium files are easily broken; note the following points.
 - Open the canal up to the apical constriction manually before using a nickel-titanium file.
 - Never use excessive force to insert the file.
 - First remove all foreign matter, such as bits of cotton from the root canal.
 - Never use excessive force to advance the file down the root canal.
 - Do not use for extremely curved canals.
 - Try not to trigger the auto torque reverse function when advancing the file down the canal.
 - Do not skip file sizes; suddenly using a much larger file could break it.
 - If you encounter resistance or the auto torque reverse is triggered, back the file up 3 or 4 mm and carefully advance it down the root canal again. Or replace the file with a smaller size. Never use excessive force.
 - Do not force the file down the root canal or press it against the root canal wall.
 - Do not use the same file continuously in one position as this may create "steps" on the root canal wall.
- Always take file out of the contra angle after use.

(3) Operation

Basic Operation

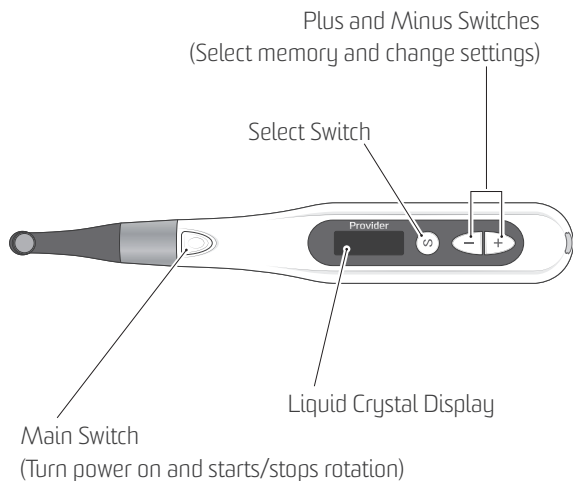

Standby Display (OTR Mode)

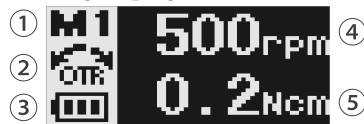

Standby Display (Normal Mode)

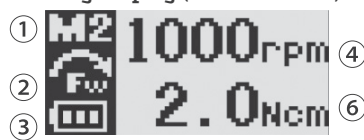

- ① Memory Number
- ② Rotation Mode
- ③ Battery Power
- ④ Speed Setting
- ⑤ OTR Torque Setting
- ⑥ Torque Reverse Setting

Torque Display

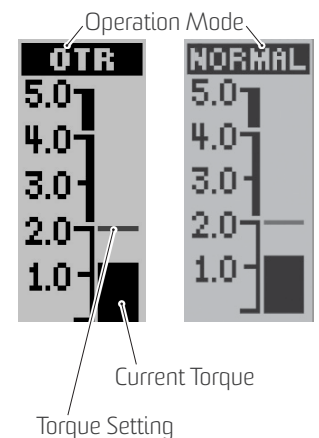

1. Turn Endostar Provider On: Press the Main Switch.

The standby display will appear.

When the standby display is being shown, you can turn the device off by holding down the Select Switch and pressing the Main Switch

2. Select Memory Number: Press the Plus or Minus Switch.

* There are six memories for various combinations of speed, torque reverse and rotation mode settings.

* The backlight will temporarily change color if changing the memory number changes anything other than the speed, torque reverse, and rotation mode settings.

3. Start Motor: Press the Main Switch again.

The torque display will appear.

* If you hold the Main Switch down when you start the motor, it will run only while the switch is held down and stop when the switch is released.

* You can temporarily change the torque reverse setting while the motor is running by pressing the Plus or Minus Switch. (This works only for normal mode.)

! When the Apical Torque Reduction is set to "ON", the torque setting cannot be temporarily changed.

* The color of the backlight changes depending on the load applied to the file.

* The backlight starts blinking when the load approaches the reverse setting. While the OTR is triggered, the backlight does not blink.

4. Stop Motor: Press the Main Switch again.

The standby display will reappear.

5. Turn Endostar Provider Off: Hold the Select Switch and then press the Main Switch.

* The device turns itself off automatically if it is not used for 3 minutes (initial setting).

For meter readings and operation connected to the Endostar Navigator; p. 20 "Meter Display"

! WARNING

- Be sure to check the new settings whenever you change the Memory Number.

! CAUTION

- The temperature at the position 8 cm from the contra angle tip rises up to +48.3°C (+118.9°F) when the ambient temperature is +35°C (+95°F).
- When the OTR seems to be triggered too frequently, or it is triggered immediately after starting the normal rotation, increase the torque setting by one level.

Memory Settings: Initial Settings

The initial settings are shown below. These settings can be changed.

Setting	Memory					
	M1	M2	M3	M4	M5	M6
Speed (rpm)	500	300	500	500	300	500
Reverse Torque (Ncm)	0.2	0.2	0.2	1.0	1.0	1.0
Rotation Mode	OTR	OTR	OTR	Normal (Forward)	Normal (Forward)	Normal (Forward)
Torque Slow Down	—	—	—	Off	Off	Off
Linked Function**	On	On	Off	On	On	Off
Apical Reverse or Stop**	Reverse	Reverse	—	Reverse	Reverse	—
Auto Start or Stop**	On	On	Off	On	On	Off
Apical Slow Down**	—	—	—	Off	Off	Off
Apical Torque Reduction**	—	—	—	Off	Off	Off

** These functions are available only when connected to the Endostar Navigator.

Memory Settings: Primary Functions

Primary Functions: Speed, Rotation Mode

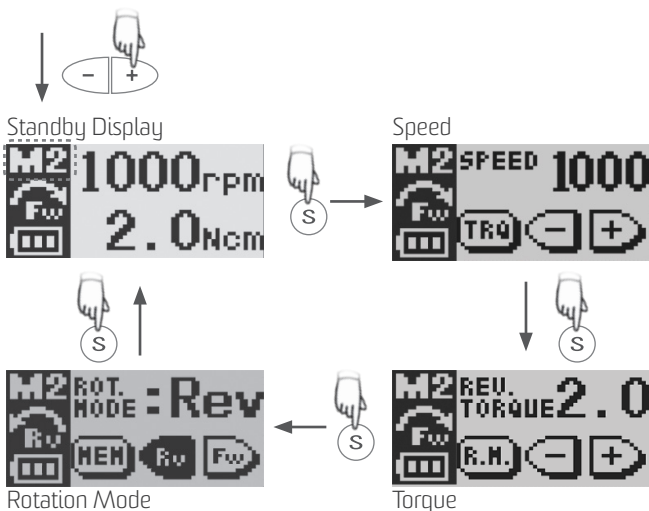

Speed Settings:

< OTR Mode >

100, 300, and 500 rpm

< Normal Mode >

50, 100, 150, 200, 250, 300, 400, 500, 600, 800, and 1000 rpm

1. Select a memory number for the standby display by pressing the Plus or Minus Switch.
2. Press the Select Switch to choose one of the primary functions.
3. Press the Plus or Minus Switch to change the setting.

* The display will go back to the standby display if 5 seconds (initial setting) elapses without a switch being pressed.

! Torque reverse values may differ somewhat depending on the motor and contra angle.

Torque Settings:

< OTR Mode >

0.2, 0.4, 0.6, 0.8, and 1.0 Ncm

< Normal Mode >

0.2, 0.4, 0.6, 0.8, 1.0, 1.5, 2.0, 2.5, 3.0, 4.0, and 5.0 Ncm

This function can also be turned off: TRL (torque reverse-less).

Rotation Mode:

Normal (Fwd: Forward, Rev: Reverse) or OTR

CAUTION

- If the torque limit is too high, the file could jam inside the canal and break.
- The torque settings must be changed depending on the root canal condition and the file.
- If the torque reverse seems to be activated too frequently increase its value.
- When OTR mode (motor runs back and forth continuously) seems to be triggered too frequently, or it is triggered immediately after starting the normal rotation, increase the torque setting by one line.

Memory Settings: Additional Operation Settings (OTR Mode)

Additional Functions: Linked Function (Linked Func.**), Apical Reverse or Stop (APICAL ACT.**)
Auto Start or Stop (AUTO STT/STP**)

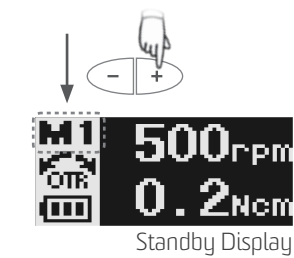

1. Select a memory number for the standby display; press the Plus or Minus Switch.
2. Hold down the Select Switch for at least 1 second to show the displays for additional operation settings.
3. Press the Select Switch to go from one display to the next.
4. Change the setting; press the Plus or Minus Switch.

* The display will go back to the standby display if 5 seconds (initial setting) elapses without a switch being pressed.

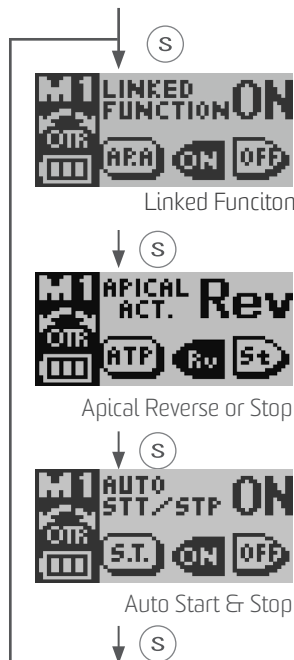

Linked Function**:

When this is set to "ON", Apical Reverse or Stop function be activated.

Apical Reverse or Stop**:

The file will reverse or stop when the file tip reaches the Flash Bar.
When Linked Function is set to "ON", this display will be skipped.

Auto Start & Stop**:

When this is set to "ON", the file starts rotating when it is inserted and stops when it is taken out of the canal.

** These functions are available only when connected to the Endostar Navigator.

Memory Settings: Additional Operation Settings (Normal Mode)

Additional Functions: Torque Slow Down (TORQ.SL.D.), Linked to canal measurement (APICAL ACT.**), Apical Reverse or Stop (APICAL ACT.**), Auto Start and Stop (AUTO STT/STP**), Apical Slow Down (APICAL SL.D.**), Apical Torque Reduction (APICAL TRQ.D.**)

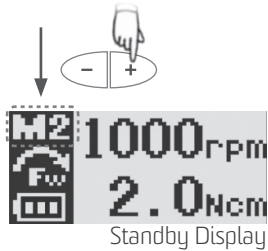

1. Select a memory number for the standby display; press the Plus or Minus Switch.
2. Hold down the Select Switch for at least 1 second to show the displays for additional operation settings.
3. Press the Select Switch to go from one display to the next.
4. Change the setting; press the Plus or Minus Switch.
 - * The display will go back to the standby display if 5 seconds (initial setting) elapses without a switch being pressed.

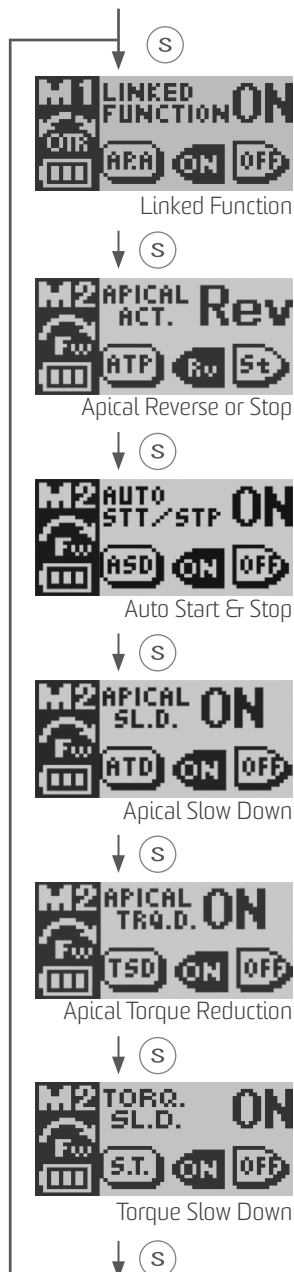

Linked Function**:

When this is set to "ON", Apical Reverse or Stop function be activated.

Apical Reverse or Stop**:

The file will reverse or stop when the file tip reaches the Flash Bar.

When Apical Action Function is set to "OFF", this display will be skipped.

Auto Start & Stop**:

When this is set to "ON", the file starts rotating when it is inserted and stops when it is taken out of the canal.

Apical Slow Down**:

When this is set to "ON", the file slows down as it approaches the Flash Bar.

⚠ Cannot be used along with Apical Torque Reduction function.

Apical Torque Reduction**:

When this is set to "ON", the torque setting that triggers reverse rotation is reduced as the file tip approaches the apex.

⚠ Cannot be used along with Apical Slow Down or Torque Slow Down functions.

⚠ If the Torque Reverse Less (TRL) is set to "ON", the Apical Torque Reduction function is disabled.

Torque Slow Down:

When this is set to "ON", the motor will slow down as the torque load increases.

⚠ Cannot be used along with Apical Torque Reduction function.

⚠ If the Torque Reverse Less (TRL) is turned on, the Torque Slow Down function is disabled.

** These functions are available only when connected to the Endostar Navigator.

Memory Settings: Other Settings

Other Settings: The initial settings are shown below.

Beeper (BEEP VOLUME)	Big	Right or Left Handed (DOMI. HAND)	Right
Auto Power Off (AUTO PWR)	3 min.	Backlight (B.L.COLOR CHANGE)	On
Positive or Negative Display (DISP. TYPE)	Posi	Return to Standby Time (S.S.R TIME)	5 sec.

1. With the device turned off, hold down Select Switch and then press the Main Switch.
2. Press the Select Switch to select one of the settings.
3. Press the Plus or Minus Switch to change the setting.
4. Press the Main Switch to return to the standby display.

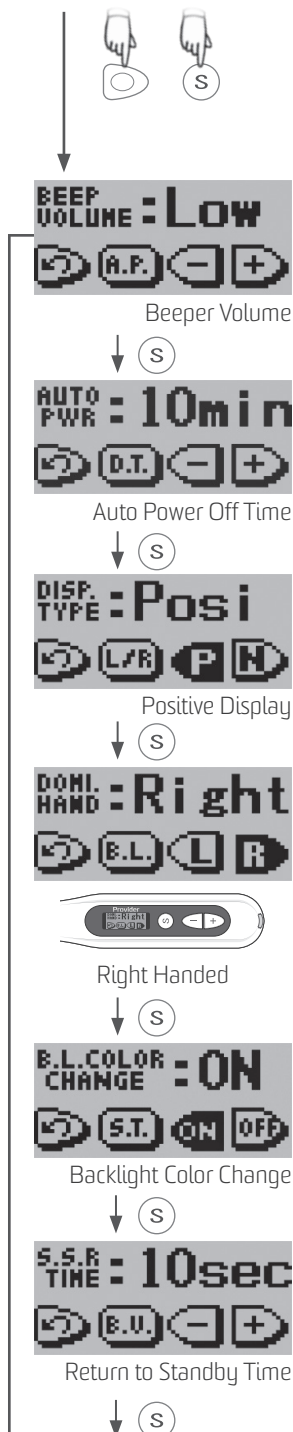

Beeper Volume:

Press Plus or Minus Switch to set beep volume used for switch operation and alarms at off, Low or Big.

Auto Power Off Time:

The time lapse for automatic shut off when the device is not used can be set from 1 to 15 minutes. Press the Plus or Minus Switch to set the time.

Positive or Negative Display:

Set display for black on white background or vice versa.

Right or Left Handed:

Set display for right- or left-handed user. Display turns upside down for left-handed users.

Backlight Color Change:

When this is set to "ON", the backlight will change color depending on torque and file tip location. It also changes color for setting displays. Does not change color when the setting is set to "OFF".

Return to Standby Time:

Set the time that elapses before display returns to standby from settings displays. Set from 1 to 15 seconds by pressing the Plus or Minus Switch.

Restoring the Initial Settings

Restore the initial settings for the memories in the following way.

* This will restore the original memory settings. You cannot restore settings for just one memory.



1. With the device turned off, hold down the Select Switch, the Plus Switch and the Minus Switch and then turn the device on with the Main Switch.
2. The "MemClear" display will appear. Press the Select Switch to restore the default memories or press the Main Switch to cancel the operation.
3. Wait until the "Finished" display appears and then press the Main Switch to go to the standby display.

(4) After Using the Endostar Provider

Removing the File

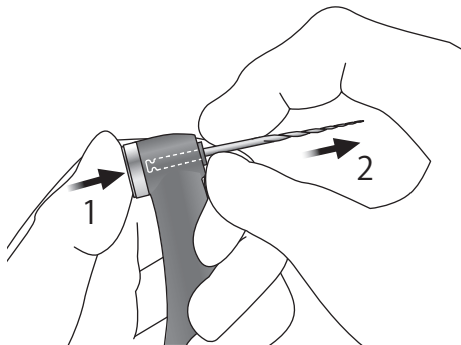

1. Hold down the Select Switch and press the Main Switch to turn the power off.

* The power will go off automatically if the device is not used and no switches are pressed for 3 minutes.



2. Hold down the file release button and pull the file straight out.

CAUTION

- Take care not to injure your fingers when inserting and removing files.
- Never insert or remove files without holding down the button; this will damage the chuck.
- Make sure the device is turned off before inserting or removing files.

Operation with Endostar Navigator



Installing the File Electrode

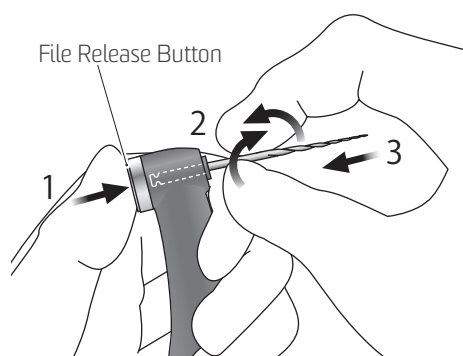

1. Hold down the file release button
2. Insert the file and turn it back and forth until it lines up with the latch mechanism.
3. Push the file all the way into the latch. Release the file release button.



- ! It's easiest to hold the button down if you put your index finger where the head joints the body.
- ! Use either Nickel-titanium or stainless steel files.

WARNING

- Some files cannot use the built-in electrode to make measurement; always check for conductivity before using a file.
- Make sure the file goes all the way in. Give the file a light tug to confirm it is securely held in place. If the file is not securely placed, it could come out and injure the patient.
- Never use stretched, deformed or damaged files.
- Do not use reciprocal files (ones made to rotate back and forth). These could perforate the apical foramen when they reverse rotation.
- Make sure the screw is tight enough. Otherwise, it might come out and be swallowed. Also, measurements might not be accurate.

CAUTION

- Inserting and removing files without holding the file release button down will damage the chuck.
- Do not connect the file electrode if the motor handpiece is not connected to the Endostar Navigator.
- Use only Ni-Ti or properly designed stainless steel files.
- Use caution when inserting and removing files to avoid injury to fingers.
- Make sure the device is turned off before inserting or removing files.
- Do not let the cutting part of the file touch the electrode; this will wear it out very quickly.
- Some files cannot be used with this electrode.
(E.g., Those with a file diameter of more than 1.2 mm; Those with chuck shanks that are not perfectly round; Gates-Glidden Drills; and those that have cutting sections with large diameters such as largo burs.)
- Do not use files shanks larger than the ISO standard: Diameter 2.334 to 2.350 mm
- After use, be sure to take the file out.

Connecting the Transmission Cable

* Refer to the user manual for the Endostar Navigator.

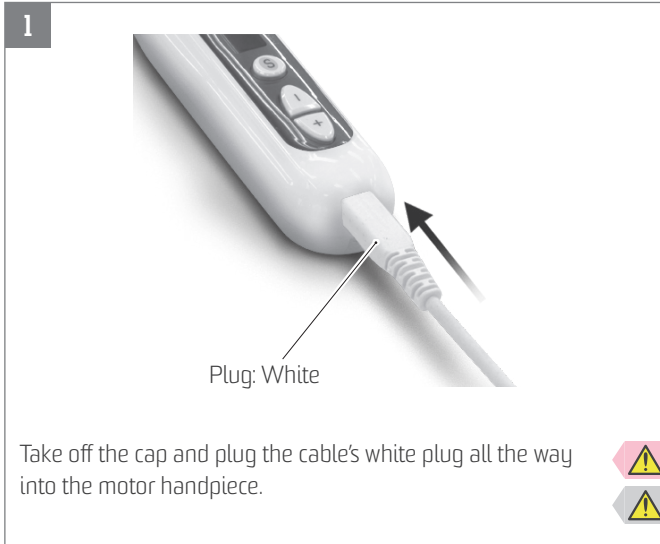

- ! Do not mix up the cable plugs.
- ! Do not put stress on the transmission cable by twisting, bending, or stretching by wrapping it around the device or Endostar Navigator.

Operation Check

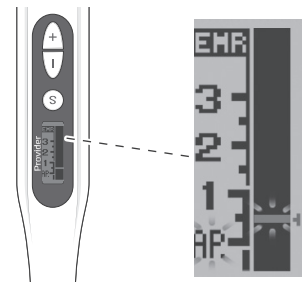
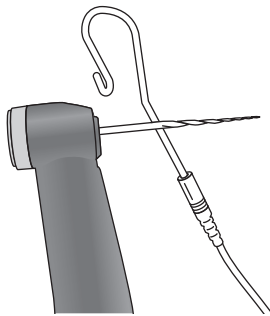

- Make sure file electrode is making good contact with the file.
 - Touch the file with the contrary electrode and make sure the meter goes all the way to its end and there are no segments that do not light up.
- 

- ! Watch out because the motor might start up when you do this.

WARNING

- Use only the special cable provided. Other cable could be electrically risky and result in damage or injury. Make sure the file goes all the way in. Give the file a light tug to make sure it is properly installed.
- Check the meter activity before each patient and do not use the device if all the segments of the display do not light up. This suggests that the meter cannot make an accurate reading.

CAUTION

- Make sure the plugs go straight in.
- After insertion give plugs a light tug to make sure they are securely connected. Otherwise, data may not be transmitted accurately.
- Do not bump the plugs or drop anything on them when they are plugged in.

Meter Display

* For more information about canal measurement and usage precautions, refer to the user manual for the Endostar Navigator.

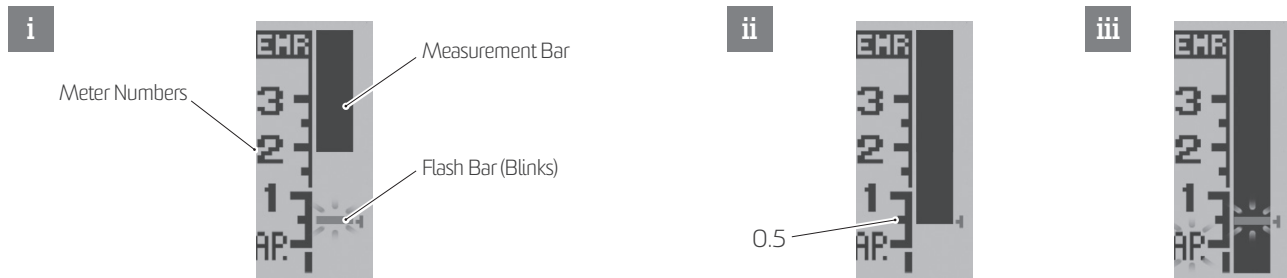

- i. The measurement bar shows the location of the file tip. The flash bar blinks when the file is inside the canal.
- ii. The 0.5 meter reading shows where the file tip is about 0.5 to 1.0 mm from the anatomical apex.
 - * The numbers 1, 2, and 3 on the meter do not indicate length in millimeters.
- iii. If the file tip goes past the flash bar, an alarm will sound and the backlight will blink.



Operation

1

Contrary Electrode

Turn on the device and the Endostar Navigator. The backlight for the display will be yellow.

Hook the contrary electrode in the corner of the patient's mouth.



WARNING

- In some cases such as a blocked root canal, a measurement cannot be made. (For details, refer to the section of the Endostar Navigator manual that covers canals not suitable for measurement.)
- Accurate measurement is not always possible, especially in cases of abnormal or unusual root canal morphology; always take an X-ray to check the measurement results.
- If the meter does not move when the file is inserted, the device may be malfunctioning and must not be used.
- Do not use an ultra sonic scaler while the contrary electrode is hooked in the patient's mouth; noise from the scaler could cause the motor to start running resulting in an accident or injury.
- Absolutely never allow the contrary electrode, the handpiece file electrode or the connections for these to contact an ordinary AC power source such as a socket; this could result in a very serious and dangerous shock.

CAUTION

- Occasionally the meter will make a sudden and large movement as soon as the file is inserted into the root canal, but it will return to normal as the file is advanced down towards the apex.
- The contrary electrode, file electrode and metal parts of the contra angle could cause an adverse reaction if the patient has an allergy to metals. Ask the patient about this before using the device.
- Take care that medicinal solutions such as formalin cresol (FC) or sodium hypochlorite do not get on the contrary electrode or the contra angle. These could cause an adverse reaction such as inflammation.
- The file electrode cannot be used with the following types of files. Use these files without attaching the file electrode. Files with a shank diameter greater than 1.2 mm, Files with shanks that do not have a circular cross section, Gates-Clidden Drills, Tools with large cutting heads such as largo burs.

Operation

2



Select a memory number (M1 to M6) with the Plus or Minus Switch.

* Before using motor handpiece, use a small hand file, such as #10 or #15, to penetrate the root canal manually down to the apical constriction.

* In some cases, a root canal cannot be measured because of an overflow of blood, saliva or chemicals or because the root canal is blocked.

3

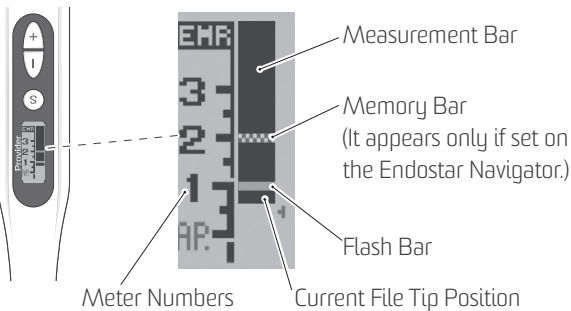

The meter display appears when the file is inserted in to the canal. If the Auto Start and Stop is set to "ON", the motor will start running too.



* The numbers 1, 2, and 3 on the meter do not indicate length in millimeters but are used to estimate how far the file tip has gone down the canal.

* Press the Select Switch to change the display to the Torque display. Press it again to go back to the canal meter display.

The motor will stop when the file tip reaches the point specified by the flash bar.

A single sustained beep will sound when this happens. If the Apical Reverse or Stop function is set to "Rev", the motor will run backwards after it stops.*

If the load on the file exceeds the reverse torque setting, the motor will stop and then reverse its rotation.*

A rapid, repeated three-toned beep will sound when this happens.

The motor will stop when the file is taken out of the canal.*

Gradually increase the size of the file until the root canal preparation is completed.

If necessary, prepare the apical seat.

(* Depends on setting.)

! If the canal is very dry, the Auto Start function may not be triggered; in this case, press the Main Switch to start the motor.

⚠ WARNING

- Accurate measurements cannot be made in some cases because of shape or other conditions. Always check the measurement with an X-ray.
- Do not let the file or metal parts of the contra angle touch the oral mucosa. This could cause the motor to start running and result in injuring the patient.
- An accurate measurement cannot be made if all the connectors are not properly plugged in. If the meter does not move along with the file, stop using the device and check all the connections.

⚠ CAUTION

- The meter may not appear if the canal is infected or extremely dry. In this case, put a little hydrogen peroxide or saline solution in the canal but do not let it overflow.

Cleaning the Rotor Axle and the Built-in Electrode

* If the bars flicker during use, or if all the bars in the meter do not light up when the file touches the contrary electrode, clean the rotor axle and the built-in electrode in the following way.

1

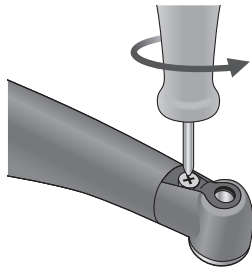

Take out the screw and then take out the built-in electrode.

2

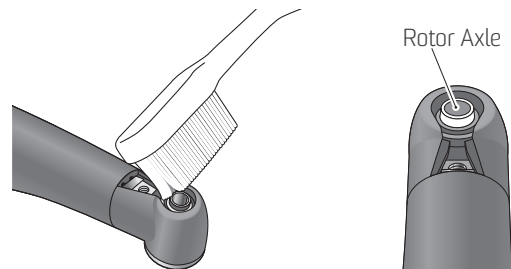

Put a little ethanol (70 vol% to 80 vol%) on a brush and clean the rotor axle with it.

3

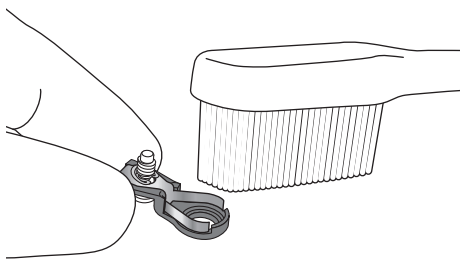

Clean the built-in electrode with the brush.

4

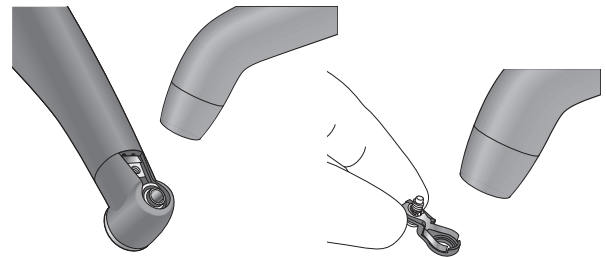

Blow air on the electrode to remove any remaining moisture.

5

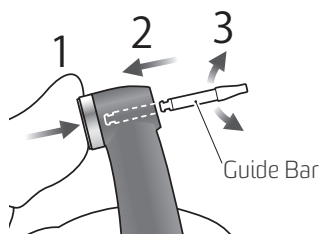

Hold the file release button and slide the guide bar straight in as shown in the illustration. Then rotate it left and right.

6

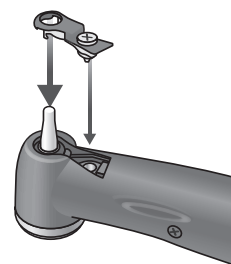

Slide the built-in electrode onto the guide bar and line up the screw holes.

CAUTION

- Do not bend or deform the electrode.
- Always use the guide bar and make sure it will not come out. If the guide bar is not properly fix in place, the internal contact could be bent, and then the device might not be able to make accurate measurements or else it might malfunction.
- Do not run the motor with the guide bar inserted; this could damage the device.

Cleaning the Rotor Axle and the Built-in Electrode

7

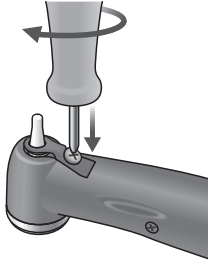

Slowly turn the screw and make sure the built-in electrode goes into the head properly.

8

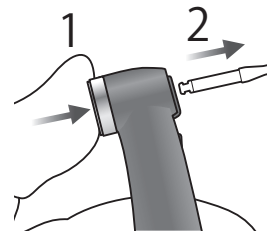

Tighten the screw up securely and then hold down the file release button and pull out the guide bar.

9

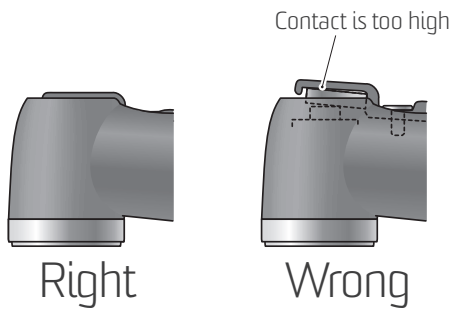

Make sure the built-in electrode is properly placed.



10

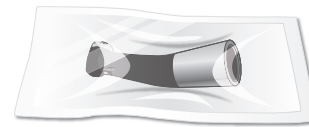

Autoclave the contra angle.
☞ p. 26 "Autoclavable Components"

WARNING

- Make sure the screw is tight enough. Otherwise, it might come out and be swallowed. Also, measurements might not be accurate.

Replacing the Built-in Electrode with the External File Electrode

! If there is no electrical conductivity between the file and its shank, replace the cap with the one that has an external file electrode (sold separately).

1

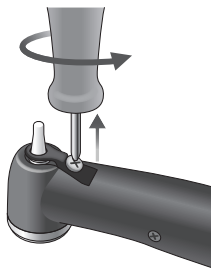

Loosen the screw and take off the built-in electrode.

2

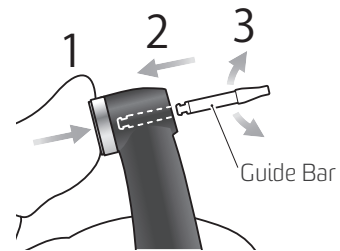

Hold the File Release Button and slide the guide bar straight in as shown in the illustration. Then rotate it left and right.



3

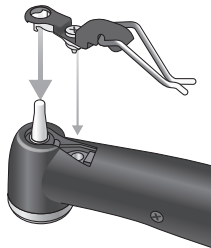

Slide the external file electrode onto the guide bar and line up the screw holes.

4

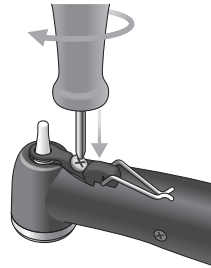

Slowly turn the screw and make sure the cap goes into the head properly.

5

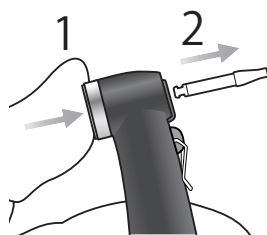

Tighten the screw up securely and then hold down the File Release Button and pull out the guide bar.



6

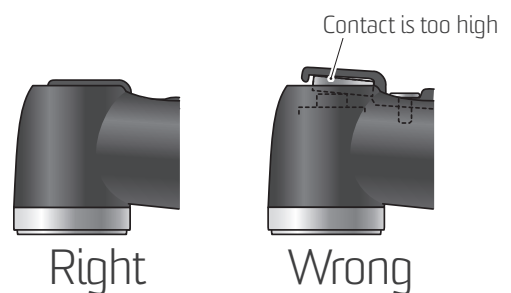

Make sure the external file electrode is properly placed.

WARNING

- Make sure the screw is tight enough. Otherwise, it might come out and be swallowed. Also, measurements might not be accurate.

CAUTION

- Always use the guide bar and make sure it will not come out. If the guide bar is not properly fix in place, the internal contact could be bent, and then the device might not be able to make accurate measurements or else it might malfunction.
- Do not run the motor with the guide bar inserted; this could damage the device.

Replacing the Built-in Electrode with the External File Electrode

7

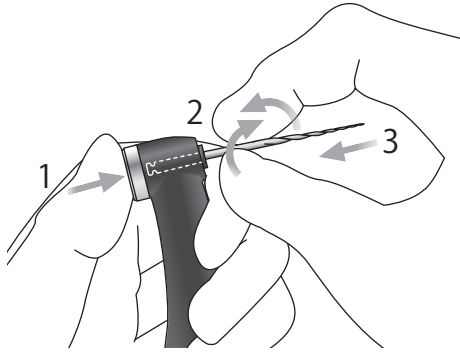

Hold the File Release Button down and turn the file back and forth until it lines up with the notch and goes all the way in. Release the button to secure it.



8

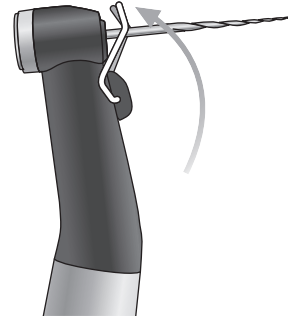

Lift the electrode up and clip it onto the file.

- ! Always clip the electrode on the file when using it. Otherwise, measurements may not be accurate or rotation may not be properly controlled. (It may not be possible to measure a canal if blood or some other liquid overflows the canal or if the canal is completely blocked.)

⚠ WARNING

- Make sure the file goes all the way in. Give it a light tug to make sure it is held securely.
- Never use stretched or other damaged files.
- Make sure the screw is tight enough. Otherwise, it might come out and be swallowed. Also, measurements might not be accurate.
- Replace the external file electrode if it is worn out as shown in the photo to the left.







⚠ CAUTION

- Do not let the cutting part of the file touch the electrode; this will wear it out very quickly.
- Some files cannot be used with this electrode.
- Also the Ni-Ti files noted below cannot be used.
 - Those with a file diameter of more than 1.2 mm.
 - Those with chuck shanks that are not perfectly round.
 - Gates-Glidden Drills
 - Those that have cutting sections with large diameters such as largo burs.
 To use these types of files, do not clip on the electrode and use the motor in manual mode.
- Do not use files with shanks larger than the ISO standard.
ISO Standard: Diameter 2.334 to 2.350 mm
- After use, be sure to take the file out.

Maintenance

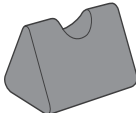
There are three ways to clean and disinfect components depending on the component. Be sure to follow the procedure below when performing daily maintenance.

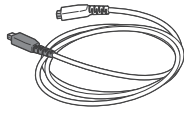
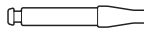

Autoclavable Components	Other Components: Wipe with Ethanol (70 vol% to 80 vol%)	Other Components: Wash and Wipe with Ethanol (70 vol% to 80 vol%)
 <p>Contra Angle</p>  <p>Handpiece Rest</p>	 <p>Motor Handpiece</p>  <p>Power Supply Cord</p>  <p>Charger</p>  <p>Transmission Cable</p>	 <p>Guide Bar</p>

Autoclavable Components

* Must be autoclaved after use for each patient.

Maintenance Procedure



* Only the contra angle needs to be lubricated.

Components maintained this way:



Contra Angle

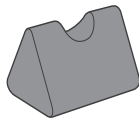

Handpiece Rest

Cleaning

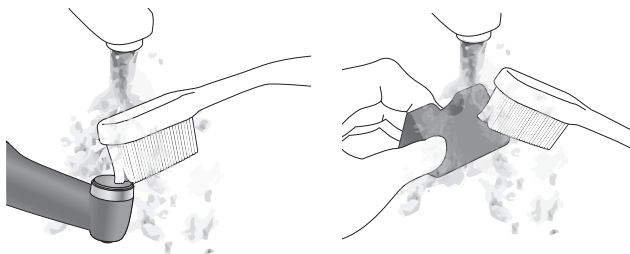

1. Disconnect the contra angle from the motor handpiece. Clean off the cutting debris with running water and a soft brush and then wipe off the water.

CAUTION

- Be careful to avoid cross contamination when performing maintenance.
- Before cleaning the contra angle, be sure to take out the file.
- If a medical agent being used for the treatment has adhered to the components, wash it off in running water.
- Do not clean the contra angle with an ultra sonic cleaning device.

Autoclavable Components

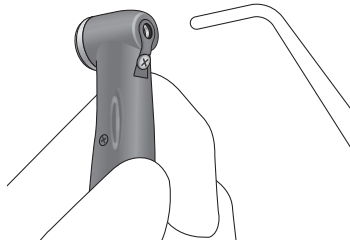

2. Use a three-way syringe etc. to blow out any moisture remaining inside the contra angle.



Disinfection

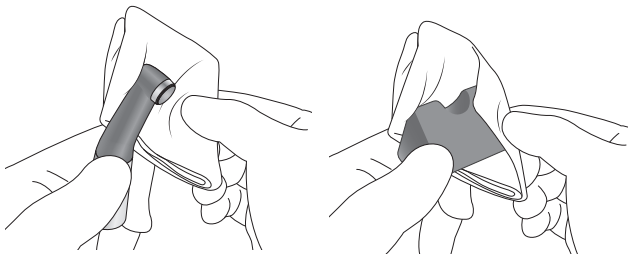

Wipe the components with a piece of gauze that has been dampened with ethanol (70 vol% to 80 vol%) and wrung out thoroughly.



Operating Conditions for High-Temperature Washer-Disinfectors

* When using a high-temperature washer-disinfector to clean the contra angle, strictly adhere to the conditions specified below.

High-Temperature Cleaning Conditions

Unit Name	Mode	Detergent (concentration)	Neutralizer* (concentration)	Rinse (concentration)
Miele C7881	Vario TD	neodisher MediClean (0.3% - 0.5%)	neodisher Z (0.1% - 0.2%)	neodisher Mieleclear (0.02% - 0.04%)

* After cleaning there may be streaks or white spots on the contra angle. Use a neutralizer only if there are streaks or white spots.

Operating Precautions

- Always use a handpiece holder when washing the contra angle, making sure to rinse the inside of the contra angle thoroughly.
- If any medical agent remains inside the contra angle, it may corrode, resulting in a malfunction of the contra angle.
- For details on handling medical agents or adjusting their concentration, refer to the user manual for the washing device.
- Check to see if the contra angle including its inside, is completely dry. If any water remains inside the contra angle, expel it with an air gun etc. Failure to do so could result in the remaining water coming out during use and cause poor lubrication or sterilization.
- Always lubricate the contra angle after washing.

- ! Inappropriate cleaning methods and solutions will damage the contra angle.
- ! Do not clean the contra angle using strong acidic or alkaline solutions that could cause the metal to corrode.
- ! Do not leave the contra angle in the high-temperature washer-disinfector.

CAUTION

- Check to see if the contra angle including its inside, is completely dry. If any water remains inside the component, expel it with an air gun or another such tool. Failure to do so could result in the remaining water coming out during use and cause malfunction, or poor lubrication and sterilization.
- If dust or other impurities enter the contra angle, they may cause poor rotation.
- Do not use anything except ethanol (70 vol% to 80 vol%). Do not use too much ethanol as it could seep inside and damage the contra angle.
- Do not immerse the components in or wipe it with any of the following: functional water (acidic electrolyzed water, strong alkaline solution, or ozone water), medical agents (glutaral, etc.), or any other special types of water or commercial cleaning liquids. Such liquids may result in metal corrosion and adhesion of the residual medical agent to the components.
- Never clean the components with chemicals such as formalin cresol (FC) and sodium hypochlorite. These will damage the plastic parts of the components. If any of these liquids being applied to the components, wash it off in running water.
- Use only ethanol (70 vol% to 80 vol%) and OPTI-CIDE-3™ Surface Wipes for cleaning. Any other cleaning chemical or products should not be used including but not limited to the following cleaning products and similar cleaning products listed below because of the potential damage to the plastic components of the device.
 - CaviWipes™
 - CaviCide™
 - SANI-CLOTH™

Autoclavable Components

Lubrication

* Only the contra angle needs to be lubricated.

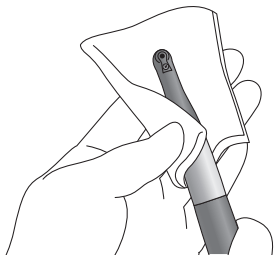
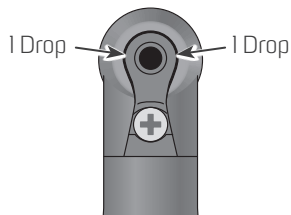
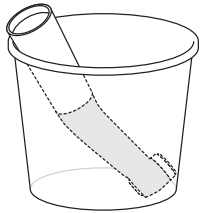

Before autoclaving, the contra angle must be lubricated with the LS OIL.

1. Place the contra angle in a paper cup with the connection end facing up.



2. Put 5 drops of the LS OIL on the gear and wait for 10 minutes.



3. Put a drop of the LS OIL in each of the two points between the built-in electrode and the head as indicated by the arrows in the illustration.

4. Take the contra angle out of the paper cup and wipe off any excess oil which may have seeped out. Dampen a piece of gauze with ethanol (70 vol% to 80 vol%), wring it out and then wipe the contra angle with it.

- ❗ Do not use anything except ethanol (70 vol% to 80 vol%) for cleaning. Never wipe the contra angle with solutions containing formalin cresol (FC) or sodium hypochlorite, which damage plastic; wipe them off immediately if they accidentally get on the contra angle.
- ❗ Do not immerse in any fluid.
- ❗ Do not connect the contra angle to the motor handpiece immediately after lubrication for use or charging. Otherwise the oil seep inside the motor handpiece and it might malfunction.

⚠ CAUTION

- Do not use any type of spray other than the LS OIL.
- Failure to lubricate the contra angle will result in a malfunction.
- Put the cap on after use. Oil could seep out if the container is tipped over or the nozzle points down.
- After lubricating, wipe oil from the outside of the nozzle. Otherwise oil may seep out from under the cap.
- Leave the contra angle in the paper cup for at least 10 minutes so that the oil is thoroughly absorbed by the contra angle mechanism.

Autoclavable Components

Packing



Put components in individual autoclave pouches.

Sterilization

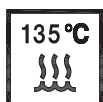

Autoclave the contra angle and handpiece rest after use for each patient.

Recommended temperature and time:

In a sterilization pouch, minimum 6 minutes at +134°C (+273.2°F) or minimum 60 minutes at +121°C (+249.8°F).

Minimum drying time after sterilization:

10 minutes.

- ! Thoroughly clean and wash the components before autoclaving. If chemical solutions or foreign debris are not removed, autoclaving could damage or deform the components.
- ! The sterilization and drying temperatures must not exceed +135°C (+275°F).
- ! No components can be autoclaved other than the contra angle and the handpiece rest.
- ! Take the file out of the contra angle before autoclaving.
- ! Be sure to lubricate the contra angle with the LS OIL before autoclaving it.
- ! Follow file manufacturer's recommendations for autoclaving files.



⚠️ WARNING

- To prevent the spread of serious, life-threatening infections such as HIV and hepatitis B, the components (contra angle, handpiece rest) must be autoclaved after each patient's treatment has been completed.

⚠️ CAUTION

- Do not sterilize the autoclavable components by any method other than autoclaving.
- Components are extremely hot right after autoclaving. Wait for them to cool off before touching.
- Do not leave the components in the autoclave.

Other Components: Wiping with Ethanol (70 vol% to 80 vol%)

Maintenance Procedure

Disinfection

Components maintained this way:



Motor Handpiece



Charger



Power Supply Cord



Transmission Cable

Disinfection

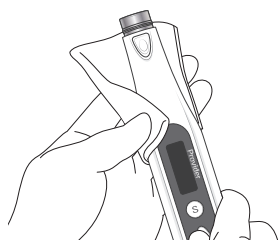

Wipe the components with a piece of gauze that has been dampened with ethanol (70 vol% to 80 vol%) and wrung out thoroughly.



CAUTION

- Do not sterilize the components by any method other than autoclaving.
- Components are extremely hot right after autoclaving. Wait for them to cool off before touching.
- Do not leave the components in the autoclave.
- Do not use anything except ethanol (70 vol% to 80 vol%). Do not use too much ethanol as it could seep inside and damage the components. Do not apply or spray with any fluid.
- Do not immerse the components in or wipe it with any of the following: functional water (acidic electrolyzed water, strong alkaline solution, or ozone water), medical agents (glutaral, etc.), or any other special types of water or commercial cleaning liquids. Such liquids may result in metal corrosion and adhesion of the residual medical agent to the components.
- Never clean the components with chemicals such as formalin cresol (FC) and sodium hypochlorite. These will damage the plastic parts of the components. If any of these liquids being applied to the components, use dry gauze etc. to wipe it off.
- Use only ethanol(70 vol% to 80 vol%) and OPTI-CIDE-3™ Surface Wipes for cleaning. Any other cleaning chemical or products should not be used including but not limited to the following cleaning products and similar cleaning products listed below because of the potential damage to the plastic components of the device.
 - CaviWipes™
 - CaviCide™
 - SANI-CLOTH™

Other Components: Washing and Wiping with Ethanol (70 vol% to 80 vol%)

Maintenance Procedure

Cleaning



Disinfection

Components maintained this way:

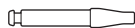

Guide Bar

Cleaning

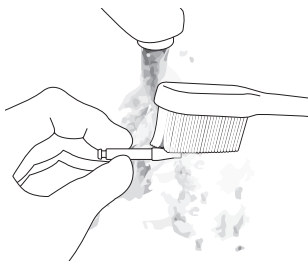

Clean off the cutting debris in running water with a soft brush and then wipe off the water.



Disinfection

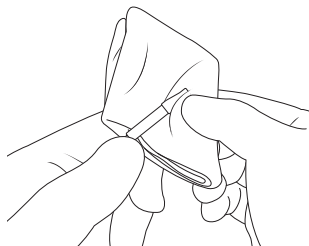

Wipe the component with a piece of gauze that has been dampened with ethanol (70 vol% to 80 vol%) and wrung out thoroughly.



CAUTION

- Do not clean the component with an ultra sonic cleaning device.
- Do not use anything except ethanol (70 vol% to 80 vol%).
- Do not immerse the component in or wipe it with any of the following: functional water (acidic electrolyzed water, strong alkaline solution, or ozone water), medical agents (glutaral, etc.), or any other special types of water or commercial cleaning liquids. Such liquids may result in metal corrosion and adhesion of the residual medical agent to the component.
- Never clean the component with chemicals such as formalin cresol (FC) and sodium hypochlorite. These will damage the plastic parts of the components. If any of these liquids being applied to the component, wash it off in running water.
- Use only ethanol (70 vol% to 80 vol%) and OPTI-CIDE-3™ Surface Wipes for cleaning. Any other cleaning chemical or products should not be used including but not limited to the following cleaning products and similar cleaning products listed below because of the potential damage to the plastic component of the device.
 - CaviWipes™
 - CaviCide™
 - SANI-CLOTH™

Replacement Parts, Transport and Storage Environments

(I) Replacement Parts

* Replace the parts as necessary depending on degree of wear and length of use.

* Order parts from Poldent Co. Ltd.

Replacing the Battery

Replace the battery when it starts to lose power relatively quickly after being fully charged.
The battery will last for approximately 1 year under normal circumstances and use.



1

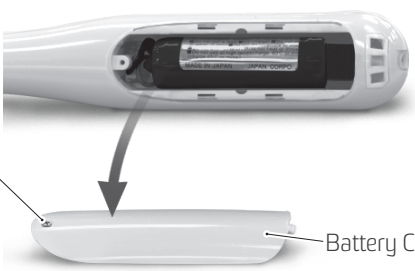

Screw

Battery Cover

Turn power off. Remove the screw and slide the battery cover off.

2



Connector

Take out the old battery and disconnect it.

⚠ Do not leave the power on when disconnecting the battery.

3

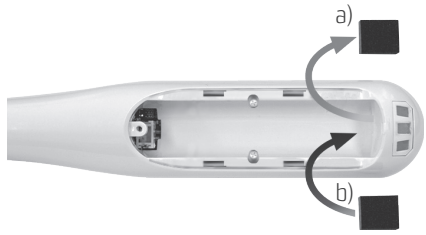

a)

b)

a) Remove an old cushion.
b) Peel off the paper shield from the sticky side of the cushion and stick it to the bottom of the battery space.

⚠ A cushion must be pasted on to fill a gap between the battery and the motor handpiece.

4



Connect the battery cord and then slide the battery along the bottom.

⚠ Dispose of old lithium ion batteries in an environmentally safe way and in strict accordance with local regulations.

5



Replace the cover and its screw.

⚠ Be careful not to pinch the battery cord when replacing the cover.
⚠ Do not tighten the cover screw too much; this could strip the threads.

⚠ CAUTION

- Use only the battery designed for the device. Other types could cause overheating.
- Do not use a battery if it is leaky, deformed, discolored or if its label is peeled off. It might overheat.

Replacing the Built-in Electrode



1

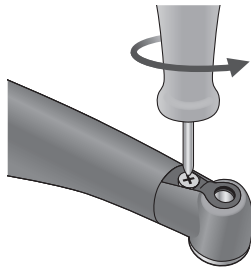

Take out the screw and then take out the built-in electrode.

2

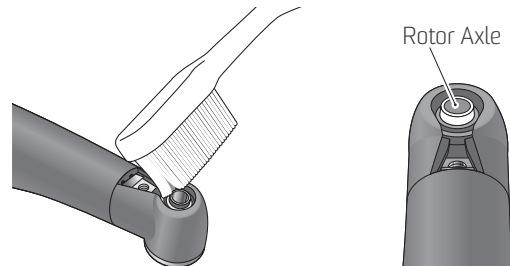

Put a little ethanol (70 vol% to 80 vol%) on a brush and clean the rotor axle with it.

3

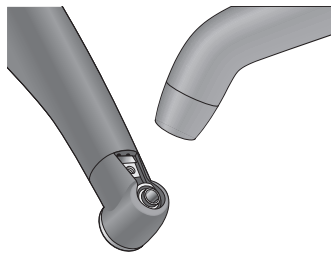

Blow air on the electrode to remove any remaining moisture.

4

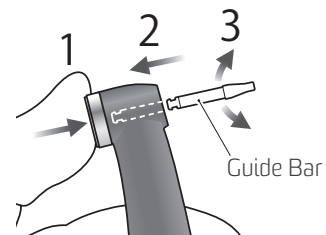

Hold the File Release Button and slide the guide bar straight in as shown in the illustration. Then rotate it left and right.



5

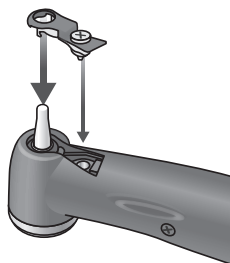

Slide the built-in electrode onto the guide bar and line up the screw holes.

6

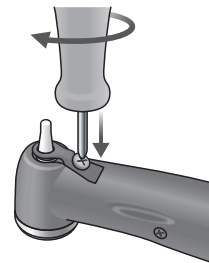

Slowly turn the screw and make sure the built-in electrode goes into the head properly.

CAUTION

- Always use the guide bar and make sure it will not come out. If the guide bar is not properly fix in place, the internal contact could be bent, and then the device might not be able to make accurate measurements or else it might malfunction.
- Do not run the motor with the guide bar inserted; this could damage the device.

Replacing the Built-in Electrode

7

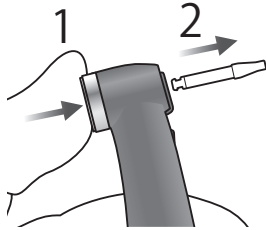

Tighten the screw up securely and then hold down the File Release Button and pull out the guide bar.

8

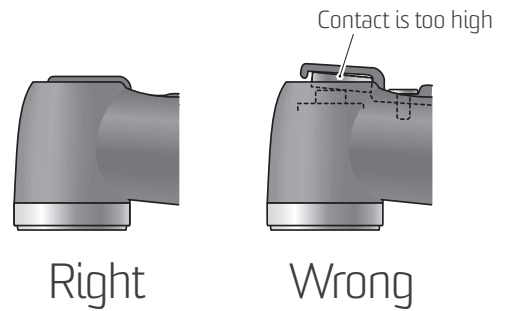

Make sure the built-in electrode is properly placed.



9

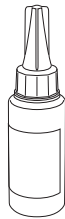

Contra angle must be lubricated with the LS OIL.
☞ p. 28 "Lubrication"

(2) Transport and Storage Environments

Temperature: -10°C to +45°C (+14°F to +113°F),
Humidity: 10% to 85% (without condensation),
Atmospheric Pressure: 70 kPa to 106 kPa

- ! Do not expose to direct sunlight frequently or for long times.
- ! If the device has not been used for a long time, make sure it works properly before using.
- ! Always remove the battery prior to storing or shipping the device.

WARNING

- Make sure the screw is tight enough. Otherwise, it might come out and be swallowed. Also, measurements might not be accurate.

Inspection and Warranty

Regular Inspection

- * Maintenance and inspection are generally considered to be the duty and obligation of the user, but if, for some reason, the user is unable to carry out these duties, contact Poldent Co. Ltd. for technical support.
- * Replace the parts listed in the Parts Lists as necessary depending on degree of wear and length of use.
- * This apparatus should be inspected every 6 months in accordance with the following maintenance and inspection items.

Inspection Items

1. Check that the battery does not seem to be losing its charge too quickly.
2. Check that pressing the Main Switch turns the device on. After the device is on, check that pressing the Main Switch turns the motor on and off. Check that the device turns off when the Main Switch is pressed while the Select Switch is being held down.
3. Check that pressing the Plus and Minus Switches changes the memory number from M1 through M6.
4. Check that the settings for each memory can be changed.
5. Make sure the connection end of the motor handpiece is not damaged or dirty.
6. Make sure that the connection end of the contra angle is not damaged or dirty and that it can be securely connected to the motor handpiece. Make sure that the file release button operates properly and that files can be securely installed.
7. When used with the Endostar Navigator, touch the file with the contrary electrode and make sure that all the segments for the meter light up properly.

* For repairs contact Poldent Co. Ltd.

Parts List

Endostar Provider Head W/ Built-in Electrode (Contra Angle)

Code No. 6970-001



Lithium-Ion Battery

Code No. 6440-820



LS OIL

Code No. 6960-011



Handpiece Rest

Code No. 6961-013

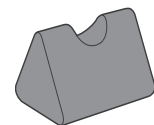

Built-in Electrode with Guide Bar

Code No. 6907-011

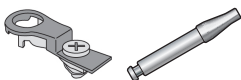

Endostar Provider Charger

Code No. 6970-002



Power Supply Cord

Code No. 6970-800



Endostar Provider Motor Handpiece

Code No. 6970-003



External File Electrode (with Cap and Guide Bar)

Code No. 6907-010

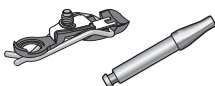

Transmission Cable

Code No. 6970-006



Maintenance and Inspection Items

■ Disposal of Medical Devices

Any medical devices which could possibly be contaminated must be first decontaminated by the responsible doctor or medical institution and then be disposed of in accordance with local laws and regulations.

The rechargeable battery should be recycled. Metal parts of the device are disposed as scrap metal. Synthetic materials, electrical components, and printed circuit boards are disposed as electrical scrap. Material must be disposed according to the relevant national legal regulations. Consult specialized disposal companies for this purpose. Please inquire of the local city/community administrations concerning local disposal companies.

■ Service

The Endostar Provider should be repaired and serviced by J. MORITA's authorized technicians. Please contact and call Poldent Co. Ltd's local dealer for more details.

Warranty

■ 2 Year Limited Warranty



1. Poldent Co. Ltd. gives a guarantee for two years beginning from the date of purchase. Within this period any defect that is due to faulty manufacturing or material will be remedied by repair or replacement at the judgment of Poldent Co. Ltd.
2. Warranty repair and service: in the event of a claim under this warranty, please contact with Poldent Co. Ltd's local dealer.
3. In the case of damage caused by wear and tear, careless handling and repairs not carried out by Poldent Co. Ltd., the warranty ceases to be valid. This guarantee may not form the basis for any claims for damages, in particular not for compensation of consequential damages. The buyer assumes responsibility for damage due to dropping of the device, improper use and utilization of product and chemicals other than those stated in this instruction manual for cleaning. It is the customer's responsibility to maintain the exact rated voltage indicated at the bottom of the device, and the office maintains electrical outlets for proper performance of the charger.
4. This warranty does not include the external accessories, built-in electrode or batteries.

Troubleshooting

If the device does not seem to be working properly, the user should first try to inspect and adjust it himself.

* If the user is unable to inspect the device himself or if the device fails to work properly after being adjusted or after parts are replaced, contact Poldent Co. Ltd.

Problem	Check Points	Response
Does not turn on.	<ul style="list-style-type: none"> Check battery power. Check battery installation. 	<ul style="list-style-type: none"> Charge battery Install battery properly.
No beeping sound.	<ul style="list-style-type: none"> Check if the Beeper Volume is set to "OFF". 	<ul style="list-style-type: none"> Set it to "Low" or "High".
Beep sounds even when device is not being used.	<ul style="list-style-type: none"> Device may be set for reverse rotation. 	<ul style="list-style-type: none"> A beep sounds periodically whenever the device is set for reverse rotation. Turn the beeper off if it is annoying. (This will stop all beeping except when the device is turned on.)
Backlight color does not change.	<ul style="list-style-type: none"> See if this function has been turned off. 	<ul style="list-style-type: none"> Turn this function on, if necessary.
Motor does not start when file is inside canal.	<ul style="list-style-type: none"> Is Endostar Navigator properly connected and turned on? Is the contrary electrode for the Endostar Navigator hooked in the patient's mouth? Is the Apical Action Function set to "OFF"? Is the Auto Start & Stop set to "OFF"? Has the meter gone past the Flash Bar? 	<ul style="list-style-type: none"> Check transmission cable connections. Turn on the Endostar Navigator. Hook the contrary electrode in the corner of the patient's mouth. Set it to "ON". Set it to "ON". Set the Apical Reverse or Stop to "Rev" (reverse).
Motor starts but then stops right away.	<ul style="list-style-type: none"> Did you hold down the Main Switch for more than 1 second? Does "Abn.Stop LowBat" appear in the display? 	<ul style="list-style-type: none"> If you hold the Main Switch down for more than 1 second, the motor runs only while the switch is held down and stops when it is released. The motor will run without stopping if you release the switch in less than 1 second. Very low battery power. Charge battery.
Motor reverses rotation on its own.	<ul style="list-style-type: none"> Check the Reverse Torque setting. Check if the Apical Reverse or Stop is set to "Rev" (reverse). 	<ul style="list-style-type: none"> The Torque Reverse can be turned off with "TRL" setting. You can change it to "Stp" (stop).
Motor reverses rotation too quickly.	<ul style="list-style-type: none"> Check the Reverse Torque setting. Is the Apical Torque Reduction set to "ON"? 	<ul style="list-style-type: none"> Increase its setting value. The torque reverse value goes down as the file approaches the apex if the Apical Torque Reduction is set to "ON". Set it to "OFF" to keep the torque reverse value constant.
Motor runs back and forth continuously.	<ul style="list-style-type: none"> Is rotation mode set to "OTR"? Does it do this even after calibration? 	<ul style="list-style-type: none"> Torque load is greater than the setting for OTR mode. Increase the setting for the Reverse Torque by 1 level.  p. 10 "Calibration"

Problem	Check Points	Response
Meter is not stable during use.	<ul style="list-style-type: none"> Does the built-in electrode need replacement? Has it been replaced recently? Is the screw for the built-in electrode loose? 	<ul style="list-style-type: none"> Clean and lubricate the contra angle. Take out the built-in electrode and clean it and the rotor axle with a brush. Replace the built-in electrode. Tighten the screw.
Motor handpiece will not go in reverse rotation.	<ul style="list-style-type: none"> Is the Reverse Torque set to "TRL" (torque reverse less)? Is Reverse Torque setting too high? Is the Apical Action Function set to "OFF"? Is the Apical Reverse or Stop set to "Stp" (stop)? 	<ul style="list-style-type: none"> Change the setting to other than "TRL". Reduce the torque reverse value. Set it to "ON". Set it to "Rev" (reverse).
Micromotor changes speed on its own.	<ul style="list-style-type: none"> Is the Apical Slow Down set to "ON"? Is the Torque Slow Down set to "ON"? 	<ul style="list-style-type: none"> When this is set to "ON", the motor slows down as the file approaches the apex.  p. 15 "Apical Slow Down**." When this is set to "ON", the motor slows down as the torque increases.  p. 15 "Torque Slow Down."
Device turns off or on its own.	<ul style="list-style-type: none"> Was the device no used for a long time? Does "Please Charge" appear in the display? This can happen if the battery is very low and a large load is applied to the file. 	<ul style="list-style-type: none"> Auto power off was probably activated. Press the Main Switch to turn the device back on. Battery must be charged right away. Battery must be charged right away.
Error 01	<ul style="list-style-type: none"> Turn the device off and disconnect the transmission cable; does the same error message appear when the device is turned back on? Is there some debris on the connector for the transmission cable? Does the error message appear when the transmission cable is twisted or bent sharply? 	<ul style="list-style-type: none"> If the device's operation is restored by disconnecting the transmission cable, the problem was only temporary and there is nothing wrong with it. If the same error occurs after disconnecting the transmission cable, there is probably something wrong with the device. Contact Poldent Co. Ltd. If there is, clean the connector. There could be a broken wire inside the cable; replace it with a new one.
Error 04	<ul style="list-style-type: none"> Does this happen repeatedly? 	<ul style="list-style-type: none"> There may be something wrong with the control board. (In this case, memory settings cannot be saved, but they can still be changed even though they will not be saved.)
Error 06	<ul style="list-style-type: none"> Does this happen repeatedly? 	<ul style="list-style-type: none"> The motor circuits may be malfunctioning. Have the device repaired.

Technical Specifications

Specifications

* Specifications may be changed without notice due to improvements.

Name	Endostar Provider
Model	TR-CM
Degree of Protection (IEC 60529)	IPX0
Intended Use	The Endostar Provider is a compact and cordless endodontic treatment motorized handpiece for preparation and enlargement of root canals. It can be connected to the Endostar Navigator, an apex locator (sold separately). It can be used to enlarge and prepare root canals, remove gutta-percha and softened dentin, and perform professional mechanical tooth cleaning (PMTTC).
Operating Principle	By electric drive, the Endostar Provider transmits motion, such as rotation and vibration, to treatment instruments (dental files, reamers, etc.).
Essential Performance	None (There is no unacceptable risk.)

Handpiece

Free Running Operation Speed	50 ±5 r/min to 1,000 ±100 r/min
Gear Ratio	1.9:1
Usable Burs	Type I (CA)
Rated Torque	Min. 0.04 N·m
Chuck Type	Push button latch type
Protection against Electric Shock	Internal powered ME equipment / Type BF applied part
Battery	Lithium ion battery (DC 3.7 V)
Dimensions	Approx. Dia. 28 mm × Length 196 mm (including contra angle and motor handpiece)
Weight	Approx. 100 g (including contra angle and motor handpiece)
Coupling Identification	Endostar Provider coupling
Applied Part	Contra angle, Motor handpiece

Battery Charger

Rated Input Voltage	A.C. 100 V – 240 V
Frequency	50 Hz / 60 Hz
Power Consumption	19 VA
Protection against Electric Shock	Class II / No applied part
Dimensions	Approx. Height 85 mm × Width 68 mm × Length 108 mm
Weight	Approx. 330 g

Symbols

* Some symbols may not be used.



Manufacturer



Date of manufacture



Serial number



GSI DataMatrix



Type BF applied part
(Contra angle, Motor handpiece)



Class II Equipment



Autoclavable up to +135°C (+275°F)



Supports high-temperature cleaning and disinfection.



Keep away from rain



This way up



Fragile



Temperature limitation



Refer to instructions for use



Humidity limitation



Atmospheric pressure limitation



EU authorized representative under the European Directive 93/42/EEC



CE(0197) marking
Conforms with the European Directive,
93/42/EEC.
CE marking
Conforms with the European Directive,
2011/65/EU.



Marking of electrical equipment in accordance with the European Directive 2012/19/EU (WEEE)

Electromagnetic Disturbances (EMD)

Electromagnetic Disturbances (EMD)

The Endostar Provider (hereafter "this device") conforms to IEC 60601-1-2:2014 Ed. 4.0, the relevant international standard for electromagnetic disturbances (EMD).

The following is the "Guidance and Manufacturer's Declaration" which is required by IEC 60601-1-2:2014 Ed. 4.0, the relevant international standard for electromagnetic disturbances.

This is a Group I, Class B product according to EN 55011 (CISPR 11).

This means that this device does not generate and/or use internationally radio-frequency energy, in the form of electromagnetic radiation, inductive and/or capacitive coupling, for the treatment of material or inspection/analysis purpose and that it is suitable for use in domestic establishments and in establishments directly connected to a low voltage power supply network which supplies buildings use for domestic purposes.

Guidance and Manufacturer's Declaration – Electromagnetic Emissions		
This device is intended for use in the electromagnetic environment specified below. The customer or the user of this device should assure that it is used in such an environment.		
Emissions Test	Compliance	Electromagnetic Environment – Guidance
Conducted disturbance CISPR 11	Group I Class B	This device is suitable for use in all establishments, including domestic establishments and those directly connected to the public low-voltage power supply network that supplies buildings used for domestic purposes.
Radiated disturbance CISPR 11	Group I Class B	
Harmonic current ^{*1} IEC 61000-3-2	Class A	
Voltage fluctuations and flicker IEC 61000-3-3	Clause 5	

*1: Although this device is not applicable to Harmonics test since the rated power is less than 75 W, it has been tested as a reference according to limits for Class A.

WARNING

- The use environment of this device is the Home healthcare environment.
- This device needs special precautions regarding EMD and needs to be installed and put into service according to the EMD information provided in the ACCOMPANYING DOCUMENTS.
- Use of parts other than those accompanied or specified by the manufacturer could result in increased electromagnetic emissions or decreased electromagnetic immunity of this device and result in improper operation.
- Do not use this device as adjacent or stacked as possible with other. When adjoining or stacking is necessary, use it after observing whether this equipment and other equipment work properly.
- Portable and mobile RF communications equipment (including peripherals such as antenna cables and external antennas) should be used no closer than 30 cm to any part of the TR-CM, including cables specified by the manufacturer.

Electromagnetic Disturbances (EMD)

Guidance and Manufacturer's Declaration – Electromagnetic Immunity			
This device is intended for use in the electromagnetic environment specified below. The customer or the user of this device should assure that it is used in such an environment.			
Immunity Test	IEC 60601 Test Level	Compliance Level	Electromagnetic Environment – Guidance
Electrostatic discharge (ESD) IEC 61000-4-2	±8 kV contact ±2 kV, ±4 kV, ±8 kV, ±15 kV air	±2 kV, ±4 kV, ±6 kV, ±8 kV contact ±2 kV, ±4 kV, ±8 kV, ±15 kV air	Floors should be wood, concrete or ceramic tile. If floors are covered with synthetic material, the relative humidity should be at least 30%.
Electrical fast transients/bursts IEC 61000-4-4	±2 kV for power supply lines ±1 kV for input/output lines	±2 kV for power supply lines* ¹ ±1 kV for input/output lines* ¹	Mains power quality should be that of a typical commercial or hospital environment.
Surge IEC 61000-4-5	<u>AC/DC power</u> ±0.5 kV, ±1 kV line(s) to line(s) ±0.5 kV, ±1 kV, ±2 kV line(s) to earth <u>Signal input/output</u> ±2 kV line(s) to earth	<u>AC/DC power</u> ±0.5 kV, ±1 kV line(s) to line(s) ±0.5 kV, ±1 kV, ±2 kV line(s) to earth <u>Signal input/output</u> * ² ±2 kV line(s) to earth	Mains power quality should be that of a typical commercial or hospital environment.
Voltage dips, short interruptions and voltage variations on power supply lines IEC 61000-4-11	<u>dips</u> 0% U_T : 0.5 cycle (at 0, 45, 90, 135, 180, 225, 270, 315°) 0% U_T : 1 cycle (at 0°) 70% U_T : 25/30 cycles (at 0°) 25 (50 Hz)/30 (60 Hz) <u>short interruptions</u> 0% U_T : 250/300 cycles 250 (50 Hz)/300 (60 Hz)	<u>dips</u> 0% U_T : 0.5 cycle (at 0, 45, 90, 135, 180, 225, 270, 315°) 0% U_T : 1 cycle (at 0°) 70% U_T : 25/30 cycles (at 0°) 25 (50 Hz)/30 (60 Hz) <u>short interruptions</u> 0% U_T : 250/300 cycles 250 (50 Hz)/300 (60 Hz)	Mains power quality should be that of a typical commercial or hospital environment. If user of this device requires continued operation during power mains interruptions, it is recommended that this device be powered from an uninterruptible power supply or a battery.
Power frequency (50/60 Hz) magnetic field IEC 61000-4-8	30 A/m (r.m.s.) 50 Hz or 60 Hz	30 A/m (r.m.s.) 50 Hz or 60 Hz	Power frequency magnetic field should be at levels characteristic of a typical location in a typical commercial or hospital environment.
NOTE 1: U_T is the a.c. mains voltage prior to application of the test level. NOTE 2: r.m.s.: root mean square			

*1: This test is not applicable since the EUT signal cable is less than 3 m.

*2: Not applicable because it does not connect directly to outdoor cable.

Electromagnetic Disturbances (EMD)

Guidance and Manufacturer's Declaration – Electromagnetic Immunity

This device is intended for use in the electromagnetic environment specified below.
The customer or the user of this device should assure that it is used in such an environment.

Immunity Test	IEC 60601 Test Level	Compliance Level	Electromagnetic Environment – Guidance
Conducted RF IEC 61000-4-6	3 V ISM ^(a) / amateur radio frequency band: 6 V 150 kHz to 80 MHz	3 V ISM ^(a) / amateur radio frequency band: 6 V 150 kHz to 80 MHz	Portable and mobile RF communications equipment should be used no closer to any part of this device, including cables, than the recommended separation distance calculated from the equation applicable to the frequency of the transmitter.
Radiated RF IEC 61000-4-3	10 V/m 80 MHz to 2.7 GHz	10 V/m 80 MHz to 2.7 GHz	<p>Recommended separation distances</p> $d = 1.2\sqrt{P}$ <p>150 kHz to 80 MHz</p> $d = 0.4\sqrt{P}$ <p>80 MHz to 800 MHz</p> $d = 0.7\sqrt{P}$ <p>800 MHz to 2.7 GHz</p> $d = \frac{6}{E}\sqrt{P}$ <p>Portable wireless RF communication equipment</p> <p>Where P is the maximum output power rating of the transmitter in watts (W) according to the transmitter manufacturer, E is the compliance level in V/m and d is the recommended separation distance in meters (m).</p> <p>Field strengths from field RF transmitters, as determined by an electromagnetic site survey^(a), should be less than the compliance level in each frequency range^(b).</p> <p>Interference may occur in the vicinity of equipment marked with the following symbol:</p> 
	27 V/m 385 MHz	27 V/m 385 MHz	
	28 V/m 450 MHz	28 V/m 450 MHz	
	9 V/m 710, 745, 780 MHz	9 V/m 710, 745, 780 MHz	
	28 V/m 810, 870, 930, MHz	28 V/m 810, 870, 930, MHz	
	28 V/m 1720, 1845, 1970 MHz	28 V/m 1720, 1845, 1970 MHz	
	28 V/m 2450 MHz	28 V/m 2450 MHz	
	9 V/m 5240, 5500, 5785 MHz	9 V/m 5240, 5500, 5785 MHz	

NOTE 1: At 80 MHz and 800 MHz, the higher frequency range applies.

NOTE 2: These guidelines may not apply in all situations. Electromagnetic propagation is affected by absorption and reflection from structures, objects and people.

(a) Field strengths from fixed transmitters, such as base stations for radio (cellular/cordless) telephones and land mobile radios, amateur radio, AM and FM radio broadcast and TV broadcast cannot be predicated theoretically with accuracy. To assess the electromagnetic environment due to fixed RF transmitters, an electromagnetic site survey should be considered. If the measured field strength in the location in which this device is used exceeds the applicable RF compliance level above, this device should be observed to verify normal operation. If abnormal performance is observed, additional measures may be necessary, such as reorienting or relocating this device.

(b) Over the frequency range 150 kHz to 80 MHz, field strengths should be less than 3 V/m.

(c) The ISM (Industrial, Scientific and Medical) bands between 0.15 MHz and 80 MHz are 6.765 MHz to 6.795 MHz; 13.553 MHz to 13.567 MHz; 26.957 MHz to 27.283 MHz; and 40.66 MHz to 40.70 MHz.

The amateur radio bands between 0.15 MHz and 80 MHz are 1.8 MHz to 2.0 MHz, 3.5 MHz to 4.0 MHz, 5.3 MHz to 5.4 MHz, 7 MHz to 7.3 MHz, 10.1 MHz to 10.15 MHz, 14 MHz to 14.2 MHz, 18.07 MHz to 18.17 MHz, 21.0 MHz to 21.4 MHz, 24.89 MHz to 24.99 MHz, 28.0 MHz to 29.7 MHz and 50.0 MHz to 54.0 MHz.

Essential Performance

None

Cable List

No.	Interface(s):	Max. Cable Length, Shielding	Cable Classification
1.	AC Power Cable	1.5 m, Un-shielded	AC Power Line
2.	Probe Cord	1.7 m, Un-shielded	Signal Line (Patient-Coupled Cable)
3.	Transmission Cable	1.6 m, Un-shielded	Signal Line

Memo

Memo

Distributed by

Poldent Co. Ltd.

ul Dzika 2, 00-194 Warsaw, Poland

Phone: +48 22 351 76 50 - 51, Fax: +48 22 351 76 79

E-mail: poldent@poldent.pl, endostar@endostar.eu

www.poldent.pl, www.endostar.eu



MORITA

Development and Manufacturing



J. MORITA MFG. CORP.

680 Higashihama Minami-cho, Fushimi-ku, Kyoto 612-8533, Japan

T +81. (0)75. 611 2141, F +81. (0)75. 622 4595

Morita Global Website

www.morita.com

EU Authorized Representative under the European Directive 93/42/EEC



MEDICAL TECHNOLOGY PROMEDT CONSULTING GmbH

Altenhofstraße 80, 66386 St. Ingbert, Germany T +49. 6894 581020, F +49. 6894 581021

The authority granted to the authorized representative, MEDICAL TECHNOLOGY PROMEDT Consulting GmbH, by J. MORITA MFG. CORP. is solely limited to the work of the authorized representative with the requirements of the European Directive 93/42/EEC for product registration and incident report.

